

Instruction Manual

SUPER GL *ambulance*

Valid for Version: 4.04

Effective from April, 2010

Manufacturer / Copyright:

Dr. Müller Gerätebau GmbH
Burgker Str. 133
D – 01705 Freital

Distributor:

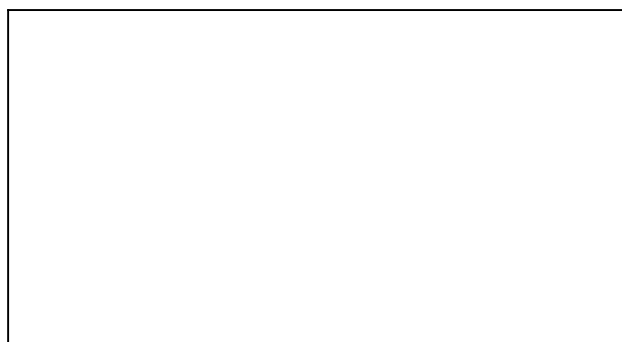

Service – Hotline:

Monday – Friday from 7 a.m. until 6 p.m.

If you have any questions concerning our products or would like to place an order, please contact:

+49 (0)351 649 12 93

+49 (0)351 64 50 42

Or contact us via:

Fax: +49 (0)351 649 15 04

Email: support@glukose.de or info@glukose.de

You will find the current version of this manual on our website
www.glukose.de

A) Table of contents:

	Page	Rev.
A..... Table of contents.....	2	04
B..... Table of figures.....	4	04
C..... Table of symbols.....	5	04
1..... Preface.....	6	04
1.1..... Introduction.....	6	04
1.2..... The SUPER GL ambulance.....	6	04
1.2.1..... Basics.....	7	04
1.2.2..... Declaration of compliance.....	8	04
1.2.3..... Device and accessories.....	9	04
1.2.4..... Overview of functionality.....	9	04
1.3..... Indication / Contraindication.....	10	04
1.4..... Manufacturer's liability.....	10	04
1.5..... Warranty.....	10	04
2..... Safety.....	11	04
2.1..... Introduction.....	11	04
2.2..... Responsibility / Training the operator.....	11	04
2.3..... General safety instructions.....	11	04
2.4..... Product-specific safety instructions.....	12	04
2.5..... Maintenance interval.....	12	04
3..... Description of analyser.....	13	04
3.1..... Introduction.....	13	04
3.2..... Intended use.....	13	04
3.3..... Measuring principle.....	14	04
3.4..... Layout and view.....	15	04
3.5..... Accessories.....	15	04
3.6..... Consumption material.....	16	04
4..... Operation - Part 1.....	17	04
4.1..... Introduction.....	17	04
4.2..... Safety instructions.....	17	04
4.3..... Installing the device.....	18	04
4.4..... Initial operation.....	19	04
4.5..... Preparing the measuring process.....	23	04
4.5.1..... Basics.....	23	04
4.5.2..... Sample preparation.....	23	04
4.6..... Measuring.....	25	04
4.6.1..... Analysis of patient samples.....	25	04
4.6.2..... Calibration.....	26	04
4.6.3..... Controls.....	26	04
4.6.4..... Method.....	27	04
4.6.5..... Printer settings.....	27	04
4.7..... Switching off the device.....	27	04





Table of figures

		Page	Rev.
5	Operation - Part 2	28	04
5.1	Introduction	28	04
5.2	Menu functions	28	04
5.3	Service programs	28	02
5.3.1	Basics	28	02
5.3.2	Statistics	28	03
5.3.3	Touch Memory	29	03
5.3.4	Washing	29	04
5.3.5	Emptying	29	04
5.3.6	Reset files	29	04
5.3.7	Service	29	04
5.4	Programming	30	04
5.4.1	Basics	30	04
5.4.2	Functions	30	04
5.4.2.1	Sample number	30	04
5.4.2.2	Daily sample no.	30	03
5.4.2.3	Adjust time	30	03
5.4.2.4	Sequence no.	30	03
5.4.2.5	Parameter list	30	03
5.4.3	Programming methods	31	04
5.4.3.1	Basics	31	04
5.4.3.2	Glucose	31	04
5.4.3.3	Lactate	31	04
5.4.3.4	Value correction	31	04
5.4.4	Select methods	32	04
5.4.5	Plasma reference glucos	32	04
5.4.6	Language	32	04
5.4.7	EDP - connection	32	04
5.4.8	Select printer	32	04
6	Maintenance and troubleshooting	33	04
6.1	Introduction	33	04
6.2	Maintenance	33	04
6.3	Servicing	33	04
6.3.1	Cleaning and disinfection	33	04
6.3.2	Exchange of pump head	34	04
6.3.3	Exchange of canula and washing chamber	35	04
6.3.4	Exchange of sensor	36	04
6.3.5	Exchange of supply and waste container	37	04
6.3.6	Exchange of batteries	38	04
6.3.7	Switching off the device	38	04
6.4	Error Messages / Troubleshooting	39	04
6.4.1	Warnings	39	04
6.4.2	Mechanical errors	40	04
6.4.3	Other errors	41	04
6.4.4	Measuring errors	43	04
7	Technical data	45	04











B) Table of figures

		Page	Rev.
Overall view SUPER GL ambulance.....	Fig. 1.1	6	04
Declaration of compliance.....	Fig. 1.2	8	04
View device.....	Fig. 1.3	9	04
Accessories.....	Fig. 1.4	9	04
Flow schema.....	Fig. 3.1	14	04
Diagram of measuring principle.....	Fig. 3.2	15	04
Overall view SUPER GL ambulance.....	Fig. 3.3	15	04
Accessories.....	Fig. 3.4	15	04
Connections SUPER GL ambulance.....	Fig. 4.1	19	04
Main program branches.....	Fig. 4.2	21	04
Menu statistics.....	Fig. 4.3	22	04
Sample preparation using open-end capillary.....	Fig. 4.4	24	04
View of pump and hoses.....	Fig. 6.1	34	04
View tilted pump.....	Fig. 6.2	34	04
View washing container.....	Fig. 6.3	35	04
View sample canula.....	Fig. 6.4	35	04
View hose holder.....	Fig. 6.5	35	04
Sensor holder closed.....	Fig. 6.6	36	04
Sensor holder open.....	Fig. 6.7	36	04
View supply and waste container.....	Fig. 6.8	37	03
View warnings.....	Fig. 6.9	39	04
View error codes.....	Fig. 6.10	40	04
Table errors messages.....	Fig. 6.11	41	03
List of technical data.....	Fig. 7.1	44	02

C) Table of symbols
Symbols on device

Symbol	Description
	Follow instruction manual
	In-vitro-Diagnostica
	Manufacturer
	CE Compliance
	serial number

Symbols on consumptions materials

Symbol	Description
	Diagnostic use <i>in vitro</i>
	CE Compliance
	Note attached documents
	Follow instruction manual
	Recyclable material
	Dispose according to regulations
	Storage temperature
	Item number
	Contents of package
	Batch number
	Use before

Symbols in instruction manual

Symbol	Description
	Attention or Note
<i>Bold/italics</i>	Very important notes

* Explanation of terms: Authorized people are people who have gained expert knowledge by completing training courses offered by the manufacturer or authorized companies.

1 Preface

1.1 Introduction

Congratulations on purchasing the SUPER GL ambulance analyser. We hope you will find working with your analyser satisfying and successful.

In the following chapter "The SUPER GL ambulance" you will find a first overview of your analyser: what parameters you can measure, what further devices and accessories belong to your analyser, and an overview of the device's functionality.

Furthermore, you will receive information on safety, on liability and warranty, and on indications or contraindications of your analyser.

For further and more detailed information, please read the corresponding chapters.

1.2 The SUPER GL ambulance

The SUPER GL ambulance analyser is a device for biochemical analysis in in-vitro diagnostics. The device is an analyser for determination of glucose and / or lactate.



Fig. 1.1 Overall view SUPER GL ambulance

1.2.1 Basics

The SUPER GL ambulance was designed using the latest technology along with decades of experience in the area of production of clinical-chemical analysers.

It fulfils all legal specifications with regard to design and production that are required of all devices used in clinical chemical laboratories. The compliance with the valid norms and statutes is documented through the visibly attached CE-Label. The CE-Label signifies compliance with all pertaining EU laws and regulations and consequently safety and confidence.

By employing an altogether newly developed technology for the determination of glucose and lactate, it is possible to fulfil all requirements of quality assurance (e.g. RiliBäk (Guidelines of the Federal General Medical Council for Quality Assurance in Medical Laboratories)) in medical laboratories while maintaining easy handling and minimum operating effort. All users are thus able to achieve analysis results that meet the quality demands.

1.2.2 Declaration of compliance

EU - Declaration of Conformity



Dr. Müller Gerätebau GmbH
Burgker Str. 133
D - 01705 Freital



The device fulfils the requirements of the following EU-norms and guidelines.
We do not guarantee the fulfilment of these norms and guidelines after unauthorized modification of the device.

name:

Analyzer
SUPER GL / SUPER GL *ambulance*

following standards and guidelines

DIN EN 61326	Electrical equipment for measurement, control and laboratory use - EMC requirements - Part 1 : general requirements.	2002-03
DIN EN 61010-1	Safety requirements for electrical equipment for measurement, control, and laboratory use - Part 1: General requirements	2002-08
DIN EN 61010-2-081	Safety requirements for electrical equipment for measurement, control, and laboratory use - Part 2-081: Particular requirements for automatic and semi-automatic laboratory equipment and other purposes	2004-07
DIN EN 61010-2-101	Safety requirements for electrical equipment for measurement, control, and laboratory use - Part 2-101: Particular requirements for in vitro diagnostics (IVD)-medical equipment	2003-09
	In-vitro-diagnostics	1998-10

The CE - mark was fixed to the device.
Valid from SUPER GL Sn 0447 and SUPER GL ambulance Sn 0491
Freital, 04.03.2008



Company Manager
Ralf Günther



Company Manager
Martin Schäfer

Fig. 1.2 Declaration of compliance

1.2.3 Device and accessories

Deliverables:

<u>Designation</u>	<u>Quantity</u>
SUPER GL ambulance	1
Sample rotor	1
Power connection cable	1
Power supply adapter for device and printer	1
Printer DPU 414	1
Printer cable	1
Instruction manual	1
<u>Optional</u>	
EDP cable	1
Other sample rotors	1



Fig. 1.3 View device

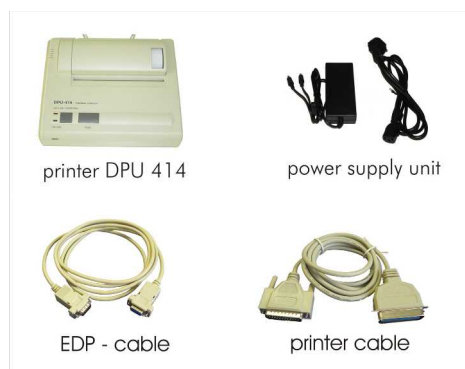

Fig. 1.4 Accessories

1.2.4 Overview of functionality

The SUPER GL ambulance analyser is an automatic analyser for the determination of glucose and / or lactate in prediluted samples at a ratio of 1+50, i.e. in hemolysed blood samples.

The device measures series up to 8 patient samples or has the possibility to measure a single sample very quick. The results of measurement will be showed at the display and will be printed out.

For further information on measuring principle and sample taking, please refer to the appropriate chapters.

1.3 Indication / Contraindication

Indication:

The SUPER GL ambulance analyser is used for measuring of glucose and / or lactate in human sample material.

Suitable sample material:

- capillary or venous or arterial blood
- serum
- plasma
- cerebro-spinal fluid
- for more materials ask the manufacturer

The sample may contain the following anticoagulants / glycolysis blockers: heparin, citrate, fluoride, EDTA.

The SUPER GL ambulance analyser must only be used and operated by trained personnel.

Contraindication:

Using unsuitable sample material can result in faulty measuring results. If in doubt, call the manufacturer!

Operating the device for home testing is expressly forbidden!

1.4 Manufacturer's liability

Legal liability and warranty claims are expressly excluded in the following cases:

- gross negligence or wilful damage of the device, parts thereof or consumption material
- unauthorized opening of the device by untrained personnel (without proper service training)
- force majeure (e.g. stroke of lightning, water damage, fire)
- nonobservance of user manual and package inserts

1.5 Warranty

For their products Dr. Müller Gerätebau GmbH gives a two-year warranty according to EU Directive 1999/44/EG starting with the day of purchase. Consumption material (because of shorter shelf-life) and parts subject to wear (they should be replaced on a yearly basis) are expressly excluded from this warranty.

For further information on spare parts and consumption material, please refer to the appropriate chapter.

2 Safety

2.1 Introduction

The following chapters concern the safety of the person operating the device.

Read these chapters carefully **PRIOR** to starting up the device because they contain general safety warnings, warnings concerning the personal safety of the person operating the device, and warnings for the protection of the device.



Displaying the following safety warnings does not release the person operating the device from adhering to the safety measures of the facility.

2.2 Responsibility / Training of the operator

- The SUPER GL ambulance analyser must only be used and operated by trained personnel. An employee of the manufacturer or of an authorized distributor will introduce the operation of the device.
- Every user is responsible for adhering to safety, health and legal regulations, and operating the device only according to its intended use.
- Interpreting the results and diagnosing on that basis must be left to a medical specialist. Operating the device for home testing is expressly forbidden.

2.3 General safety instructions

- Prior to operating the device, read the entire instruction manual especially the instructions for sample taking. If you have any questions, please contact the manufacturer or authorized distributor.
- Every person working with the device must be acquainted with the relevant safety rules prior to operating the device and these rules should be kept at hand all the time.
- Please pay attention to all general safety rules for laboratories such as wearing protective gloves, and the applicable disinfection and hygiene regulations.

- To avoid risk of electric shock, do not place the device or power supply in water or other liquids! If the cable or the power supply adapter is damaged in any way, you must not continue using the power supply. Never touch the plug of the power supply adapter with wet hands. The power supply adapter must only be used indoors and must be protected from humidity.

2.4 Product-specific safety instructions

- The device may only be used for the intended use with special attention to the defined usage restrictions and constraints that have to be strictly adhered to (if need be, contact the manufacturer).
- Operate the device only on smooth, horizontal surfaces. Avoid variations in temperature, drafts, direct sun light, and vibrations. These can result in faulty measuring values.
- In case of malfunctions, stop operating the device immediately! Prior to continuing to operate the device, read the notes concerning cleaning, error messages and troubleshooting. After consulting the manufacturer or authorized distributor you may ship the device for repairs to the manufacturer or authorized distributor.
- Use only original accessories and spare parts to avoid damage to device and people. Repairs must only be conducted by the manufacturer or by companies authorized by the manufacturer!
- The use of reagents and consumption materials that are not expressly recommended by the manufacturer can cause severe measuring errors and malfunctions and is therefore not permissible.
- If the user opens the device without authorization, the user shall not be entitled to any rights concerning the liability for the device and damages caused thereby.

2.5 Maintenance intervals

The SUPER GL ambulance needs maintenance once a year by trained personnel. The display will show the message "SERV" after expiration of the maintenance rate (only in STAND BY).

Without regular maintenance, false measuring results can occur that are not the responsibility of the manufacturer.

For further information, please refer to the chapter Maintenance / Troubleshooting.

3 Description of analyser

3.1 Introduction

This chapter describes the analyser's measuring principle, layout, accessories and the consumption material.

This chapter will provide you with forward information. For detailed instructions and descriptions of the device, please refer to chapter Operation.

3.2 Intended use

The SUPER GL ambulance analyser is an automatic analyser for the determination of glucose and / or lactate in prediluted samples at a ratio of 1+50, i.e. in hemolysed blood samples.

Suitable sample material:

- capillary or venous or arterial blood
- serum
- plasma
- cerebro-spinal fluid
- for more materials ask the manufacturer

The sample may contain the following anticoagulants / glycolysis blockers: heparin, citrate, fluoride, EDTA.



When using non-fluoride-stabilized sample material, time between taking the sample and stabilizing it with hemolysate-system-solution should not exceed 15 minutes.

With hemolysate-system-solution prediluted sample material is taken out of closed sample cups that are placed on a sample rotor. The containers for the washing and waste solution are located inside the device.

The device has the following features:

- Determination of glucose and / or lactate using the enzymatic-amperometric measuring principle
- Automatic sample measurement or sample series measurement
- autocal operation
- serial printer interface

3.3 Measuring principle

The determination of glucose and lactate with the SUPER GL ambulance is based on an electro-chemical measuring principle with a biosensor. With the help of an analyser pump system solution, calibration solution, control material or patient's material is conveyed through a sensor. The electrodes inside the sensor are separated from the liquid by sealing layers containing immobilized enzymes. The following figures show the flow schema and the reactions taking place inside the sensor:

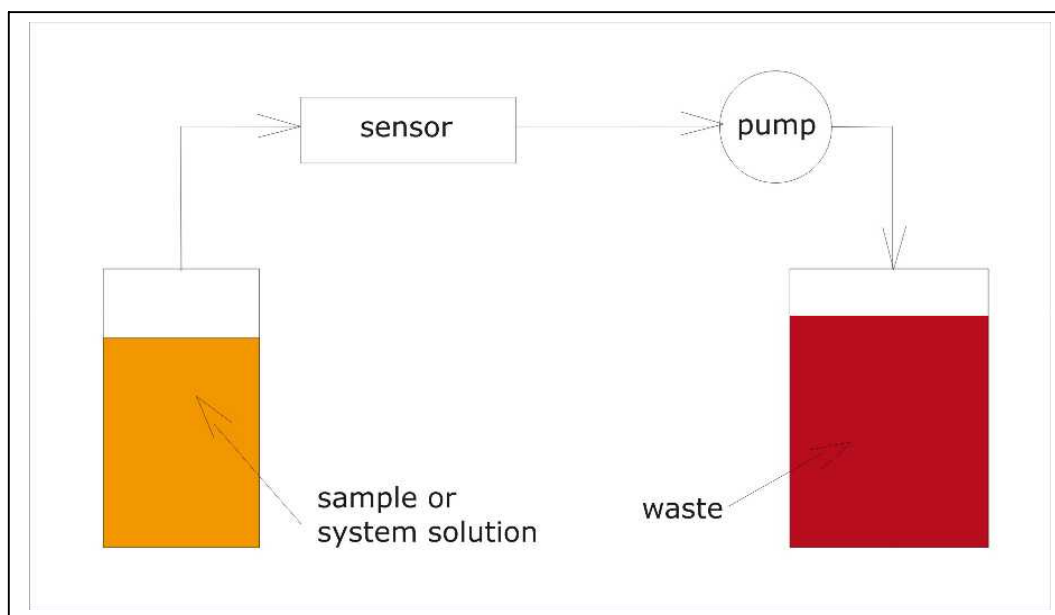

Fig. 3.1 Flow schema

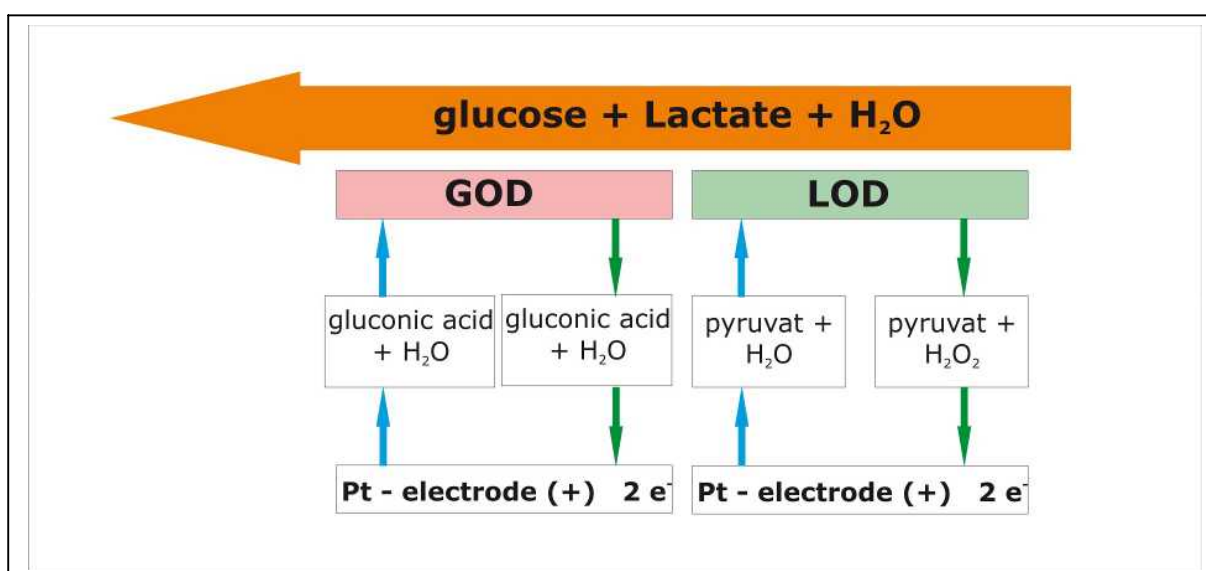

Fig. 3.2 Diagram of measuring principle

3.4 Layout and view

View



Fig. 3.3 Overall view SUPER GL ambulance



Fig. 3.4 Accessories

Deliverables:

Description	Quantity
SUPER GL ambulance	1
Sample rotor	1
Power connection cable	1
Power supply adapter for device and printer	1
Printer DPU 414	1
Printer cable	1
Instruction manual	1
<u>Optional</u>	
EDP cable	1
Other sample rotors	1

3.5 Accessories

The SUPER GL ambulance will be delivered with standard accessories as described and shown above. In addition, further optional accessories can be ordered. Both the manufacturer and the authorized distributors will gladly supply you with information about connecting interfaces.

3.6 Consumption material

To operate the analyser following consumption material is needed:

- Prefilled sample cups without capillaries or with open-end-capillaries or with end-to-end-capillaries for taking the sample
- calibration solution
- bottles with hemolysate-system-solution
- sensor glucose / lactate
- control material

For detailed instructions on the use of these consumption materials, please refer to the chapter "Operation - Part 1" of this manual.

4 Operation - Part 1

4.1 Introduction

In this part of the instruction manual, all information is included that is useful for the day-to-day operation of the device.

In part 2, all additional information is included that is important for understanding the functions, complementary functions and certain sources of possible problems.

The qualified personnel for the device must be familiar with both parts and must also have the medical knowledge to be able to interpret the acquired values correctly. Conclusions for a therapy may only be drawn by a medical specialist.

4.2 Safety instructions

As mentioned before, certain safety warnings must be heeded when operating the device to guarantee correct and faultless operation:

- The device must only be used for the described indication and must only be used and operated by trained personnel.
- Every user is responsible for adhering to safety, health and legal regulations, and operating the device only according to its intended use.
- Interpreting the results and diagnosing on that basis must be left to a medical practitioner. Operating the device for home testing is expressly forbidden.
- In daily operation, regular checks of the results should be made; if needed, an additional control measurement should be carried out.
- Do not switch off the device or disconnect it from the power supply while it is running. If this happens, malfunctions can occur the next time the device is switched on.
- If you suspect a malfunction or faulty measuring results, please inform the person responsible for the device immediately. If necessary, this person will contact the manufacturer or distributor to solve the problem.

4.3 Installing the device

Before start-up, check the supplied device and accessories for completeness referring to the list at chapter 3.4. If anything is missing, please contact your supplier immediately.

Furthermore, please check all parts for intactness. Proper and safe operation is only guaranteed when using original parts and accessories. NEVER use damaged parts or parts from other manufacturers!

Place the device on a horizontal, smooth and dry surface. Please choose a location where the device is protected from direct sunlight and extreme variations in temperature since these can impair measuring results.

Requirements on the set-up location

- no direct humidity influence
- no direct sunlight
- no strong electromagnetic fields or ionizing radiation
- no rapid changes in temperature because of windows, doors, air-conditioning and so on
- level, water-proof support
- clearance over the entire footprint

Connecting the device to the power supply (see fig. 4.1):

Please make sure that the voltage noted on the power adapter is the same as the voltage of your power grid.

The device is connected to the power supply via the delivered power supply adapter. Connect the power supply cable to the power supply adapter. Plug one end of the power supply adapter into the power connector at the back side of the device (1) and the other end into the socket.

Connecting the printer (see fig. 4.1):

If you use the SUPER GL ambulance together with the printer DPU 414, the printer is supplied with power via the second connection of the line cord.

The jack of the printer cable is inserted into the printer interface on the back side panel of the device's casing and connected to the corresponding interface on the back panel of the printer.

Connecting EDP (s. fig. 4.1):

Plug the EDP cable into the EDP-port at the back side of the device and connect the other end with your EDP. Please pay attention to the notes in the manual for interfaces and also to the notes from your EDP partner.

The following image shows the interfaces on the back side of the casing of the SUPER GL ambulance:

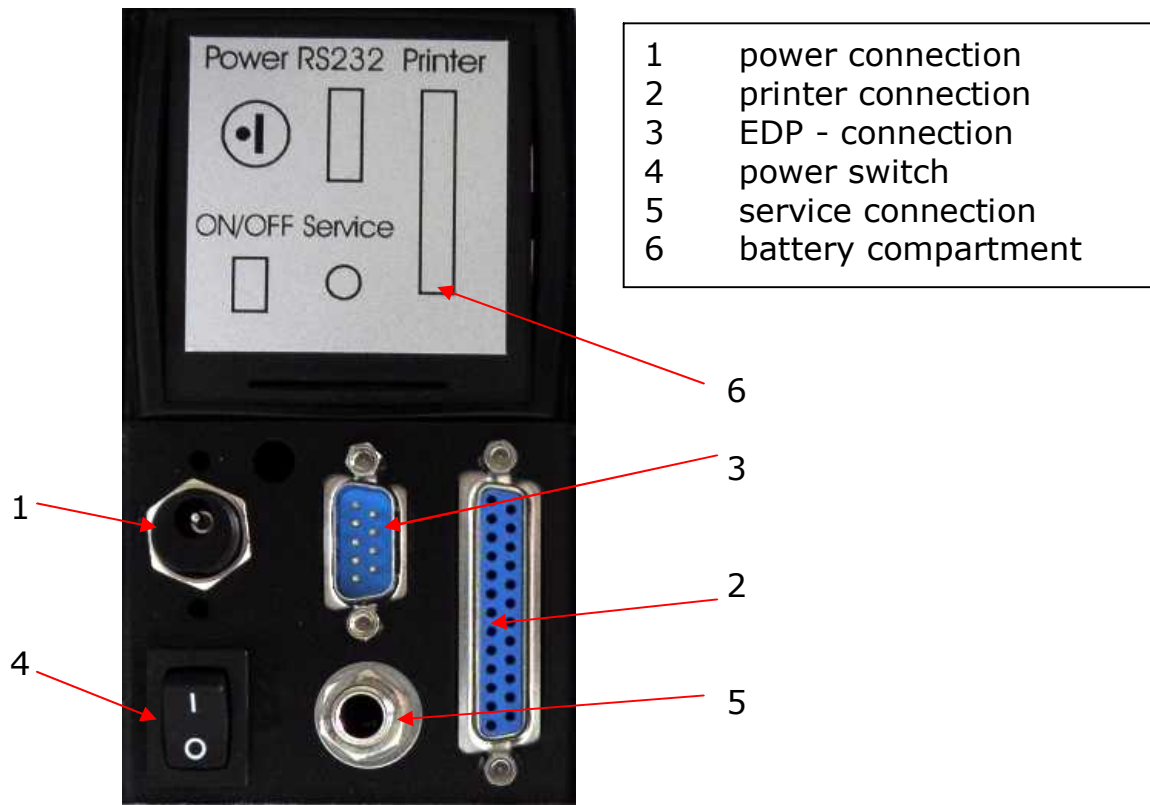

Fig. 4.1 Connections SUPER GL ambulance

4.4 Initial operation

When the device was installed as described above, proceed as follows:

- install the sensor (chapter 6.3.4)
- install the supply and waste containers (chapter 6.3.5)

This procedure completes the installation of the device. By pressing the power switch the device will be turned on.

Warning! To avoid loss of data, the device must not be switched off unless in "STAND BY" mode or if required by a corresponding error message.

After switching on the device, it will enter STAND BY mode after the necessary warm-up period.

The SUPER GL ambulance is operated with the help of a jog dial and the display.

Menu items are selected and numerical values are set by turning and pressing the jog dial. Please note that the row between the " * " can be chosen by pressing the jog dial.

While operating SUPER GL ambulance you have to note, that there are some menu points / functions which you need for day-to-day operation and there are also some you only need in service cases.

The functions of day-to-day operation you could use without any special identification and they are changeable. The service function only should be used by special trained personnel because of it is protected by a keyword.



If there are not authorized contacts in protected areas the manufacturer assumes no liability for wrong measurement results!

The following page shows the menu structure of SUPER GL ambulance. If you've got more questions, please ask the manufacturer or your distribution partner.

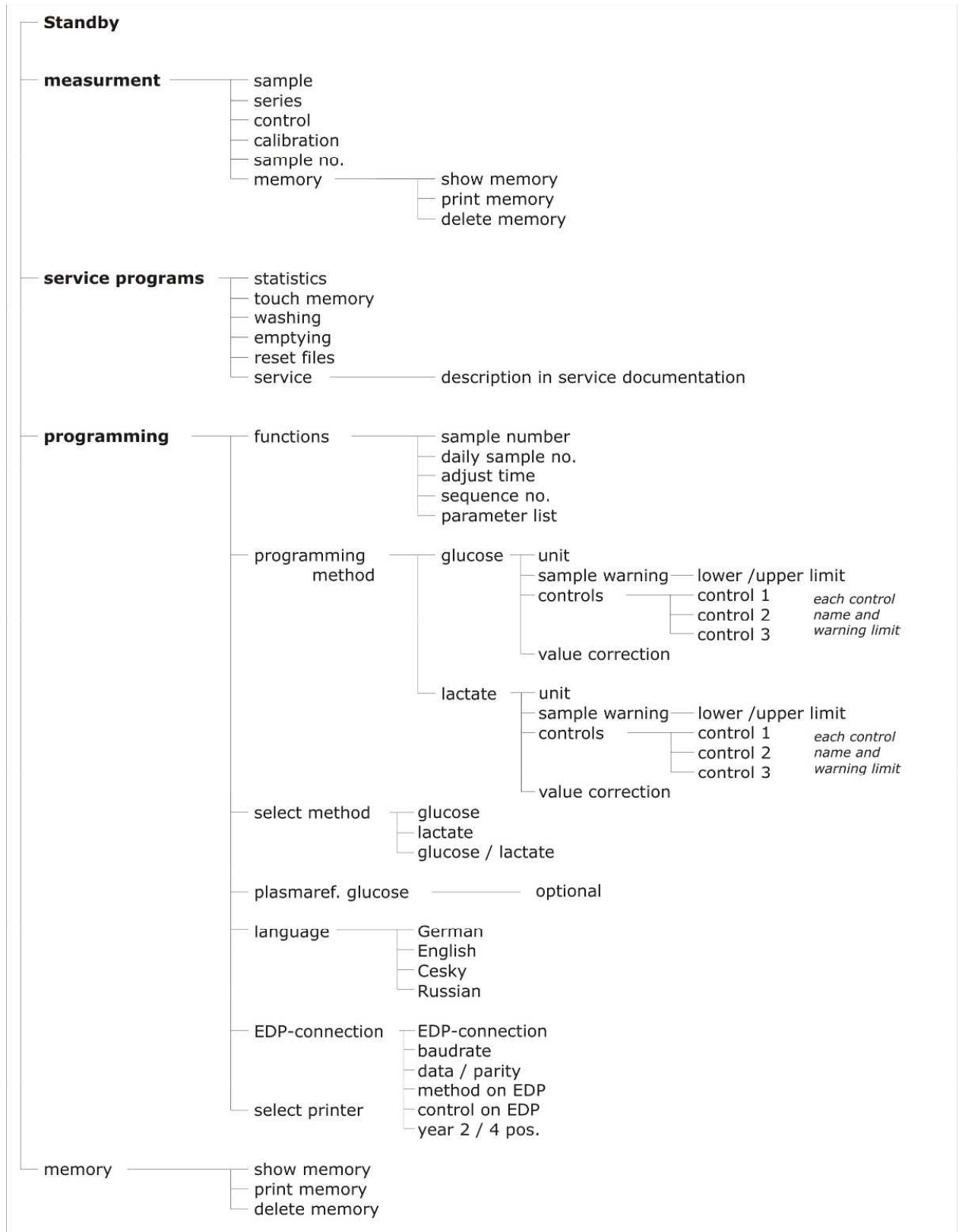

Fig. 4.2 Main program branches

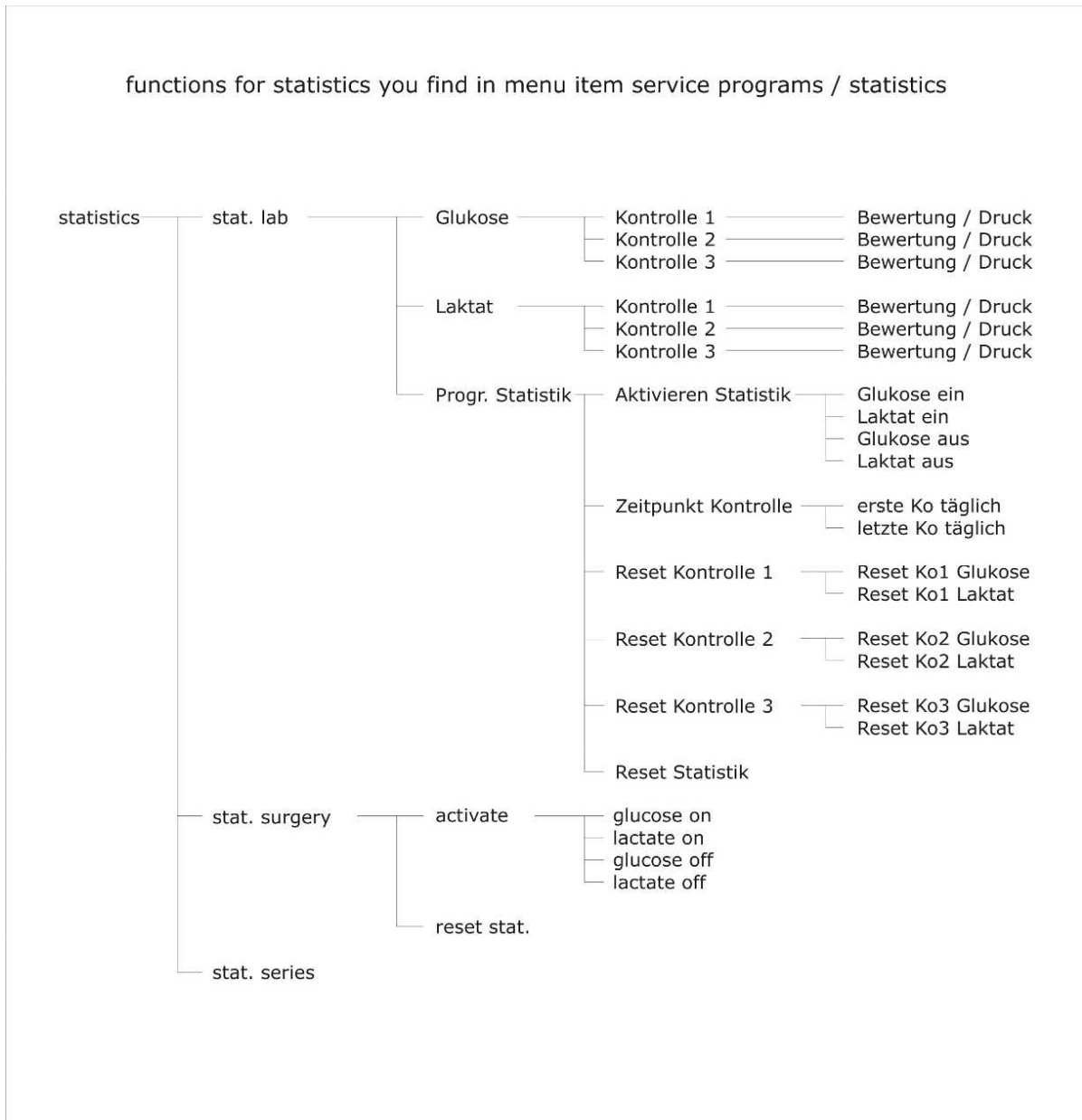

Fig. 4.3 Menu statistics

4.5 Preparing the measuring process

4.5.1 Basics

The SUPER GL ambulance uses prefilled reagents. For each analysis a prefilled reaction cup with the corresponding capillary are needed.

For measuring with SUPER GL ambulance you have also to use a biosensor, calibration cups and control material.

You have to put the sample cups into the signed positions at the sample rotor and after that you can start to measure.

4.5.2 Sample preparation

Please observe the instructions on the package insert of the reagent cups and the calibration cups concerning sample preparation!

The following notes complement the above notes and they are only valid if capillary blood is used as sample material:



When drawing a capillary blood sample, do not compress the tissue. Compressing the tissue leads to a dilution of the blood sample with intracellular fluid and can thus lead to faulty results. For taking a capillary blood sample use suitable lancets and, if necessary, circulation-enhancing measures (such as massaging the spot) to yield a sufficient sample amount.

On the following page, taking capillary blood using open-end capillaries is described and shown. Proceed likewise with an end-to-end capillary (this capillary hasn't to be broken).





	<p>Taking capillary blood from the earlobe or the finger pad and filling the capillary over both markings.</p>
	<p>Make sure, it is properly filled (sufficient amount of blood, no air bubbles, no drops of blood at the end of the capillary etc.).</p>
	<p>Carefully wipe off the outer surface of the capillary.</p>
	<p>Break the capillary at the predetermined breaking point (predetermined breaking point is located in the middle between two markings).</p>
	<p>Insert the completely filled capillary into the pre-filled sample cup.</p>
	<p>Shake sample cup until the blood has completely left the capillary.</p>

Fig. 4.4 Sample preparation using open-end capillary

4.6 Measuring

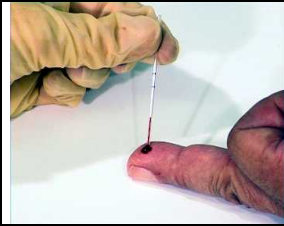
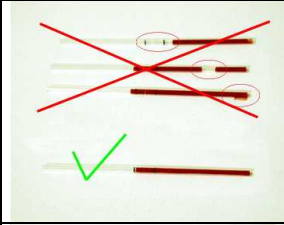
4.6.1 Analysis of patient samples

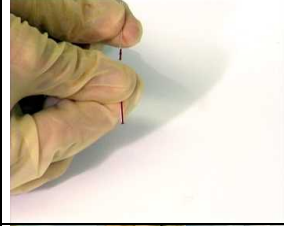
The SUPER GL ambulance allows measurements in two modes of operation. The modus depends on the sample rotor which is put into the device.

- Determination of a sample series (sample rotor for series)
- Determination of quick and control samples (sample rotor for single samples)

To start a sample series proceed as follows:

- Place sample cups in the sample rotor for series measurement. It is not necessary to start at position 1 nor have all positions to be filled because the device has automatic sample cup detection.
- In operating mode "STAND BY" press the jog dial and select the menu item "measurement". The device checks if the correct sample rotor was put on and starts to measure.

To measure a single sample proceed as follows:

- In operating mode "STAND BY" press the jog dial and select the menu item "measurement" and afterwards the menu item "Sample". The device checks if the correct sample rotor was put on and starts to measure. The device starts - if necessary - a calibration and after that it checks if there is a sample cup in sample position. Is there no cup in the sample position the LED is green.
 - The LED is green. Put a cup into the sample position.
 - The LED is red. The sample will be measured.
 - After finishing the measurement the LED is dark.
 - Remove the cup. The LED is green.
- To leave this menu item and turn to item measurement please press the jog dial.

To start a control sample series proceed as follows:

- In operating mode "STAND BY" press the jog dial and select the menu item "measurement" and afterwards the menu item "Control". The device checks if the correct sample rotor was put on and starts to measure.
- Only the occupied control positions are measured, no samples.

Prior to each of these measuring regimes, the device checks if it has a valid calibration.

Explanation to the memory:

The memory is a ring buffer for approx. 100 values of the results, after that the older values will be overwritten.

By choosing the menu item "memory" you will find the options "show memory", "print memory" and "delete memory". If you choose the item "show memory" the device shows all measured patient samples and controls. You can leave this menu item by pressing the jog dial if there is not shown the first or the last value. In menu item "print memory" all results will be printed from the chosen one until the end. The menu item "delete memory" will delete all values in the memory.

4.6.2 Calibration

To guarantee correct measuring results the SUPER GL ambulance needs a valid calibration. So the device calibrates for each option of measurement automatically. The calibrations were repeated after a fixed time management - a valid calibration is guaranteed.

In operation mode STAND BY all calibrations will be deleted and the device don't carry out a new automatically calibration.

4.6.3 Controls

The Super GL ambulance has 3 positions for control samples for meeting the requirements of quality controls.

For an effective quality management all 3 positions could be programmed. Following possibilities are programmable for each position:

- name of the control
- lower warning limit glucose
- upper warning limit glucose
- lower warning limit lactate
- upper warning limit lactate

If statistics I (lab) is activated the values of all 3 controls could be shown. You could do the data interpretation according the german RiLiBÄK 2008. Please see description in Addition I.

4.6.4 Method

Following settings are possible:

- glucose
- lactate
- glucose and lactate

4.6.5 Printer settings

The intended printer DPU 414 has several interface options.

Follow these steps for setting / programming the printer for use with SUPER GL ambulance:

1. Keep the "on Line" button pressed whole switching on the printer.
You will receive a print out of the current settings.
2. Press "On Line" again to reprogram the printer.
3. Press "On Line" for "ON" and "Feed" for "OFF"
4. Press "Feed" at the end of the programming to confirm.

The following settings are required for SUPER GL ambulance:

Position	SW1	SW2	SW3
1	ON	ON	ON
2	ON	ON	ON
3	ON	ON	ON
4	OFF	ON	ON
5	ON	ON	ON
6	OFF	ON	ON
7	ON	ON	ON
8	ON	ON	ON

4.7 Switching off the device

You may switch off the device, if there are no functions working. NEVER switch off the device during calibration or washing, otherwise the device may have malfunctions.

If the device is switched off for a longer time (i.e. during the vacation) you have to rinse and to empty the device to avoid drying the hoses. Please remove the pump head from the shaft to avoid jamming the hoses.

Please store also the consumables (i.e. sensor and calibration solution) as written at the package.

For more questions please don't hesitate to contact us.

5 Operation - Part 2

5.1 Introduction

This part of the instruction manual describes special functions and settings relevant to the user. Furthermore, it gives additional information about quality control and some problems that can be solved by the user.

5.2 Menu functions

As described in chapter 4, there are two types of device functions: functions which are needed for day-to-day operation and functions which are only should be used by trained staff.

You need for working with following functions besides special knowledge also exact knowledge about the menu structure of the SUPER GL ambulance.

The overview of the menu structure you find in fig. 4.2.

5.3 Programming

5.3.1 Basics

Following functions influence measuring results and their displaying and should only be activated by trained staff (maybe by calling the service).

5.3.2 Statistics

There are three submenus:

Statistics I Lab

The functions under this menu item are only for regulations in Germany and are described in Addition I.

Statistics II Surgery

The functions under this menu are described in Addition II.

Statistics series

With the help of this function it is possible to check the correct measuring of the device. After measuring of 8 samples with the same value mean, standard deviation and coefficient of variation were printed out.

5.3.3 Touch Memory

If you choose this menu item you get into the submenu "reading touch memory". There you find the supplies of reaction cups and hemolysate-system-solution which was read into the device. At the same time the device activates the reading equipment. Press the touch memory at this reading equipment (maybe turn it a little bit). So the supplies get into the device. By short pressing the jog dial you could leave this menu item. The touch memory conduces for saving the correct using of consumables.

5.3.4 Washing

This function washes automatically the system. Follow the instructions in the display, they're self-explanatory.

5.3.5 Emptying

Use this function if the device won't be used for a long time (i.e. vacation). Follow the instructions in the display, they're self-explanatory.

5.3.6 Reset files

This function deletes all customer-specific programmed files, i.e. control names, warning limits and so on. This function will mostly used by service or manufacturer.

5.3.7 Service

This function leads to programs which only should used by authorized personell. That's why it's protected by a code.

5.4 Programming

5.4.1 Basics

The programming of controls was shown in chapter 4.

5.4.2 Functions

In this menu item you find all programmable functions which work on all methods in the same way.

5.4.2.1 Sample number

In this submenu you could choose a digit between 001 and 999. The next sample which will be measured is signed with this digit.

5.4.2.2 Daily sample number

Daily sample number is a sample number which will be reseted every day (sample counting starts every day with 001). You could activate or deactivate this function. If the function is deactivated the sample number will be counted until 999 and will be started again with 001.

5.4.2.3 Adjust time

With this function you could change the saved time. You could choose the digit by turning and the separate number by pressing the jog dial. Because of communication between device and sensor you can't change the date.

5.4.2.4 Sequence number

This function activates or deactivates the printing out of sample number only at measuring of sample series.

5.4.2.5 Parameter list

By choosing this menu item all programmed user parameters will be printed out at the printer.

5.4.3 Programming method

5.4.3.1 Basics

In this function you will find all programmable functions which are specific for the several methods.

After selecting the menu item "programming method" you find a submenu which includes items "glucose", "lactate" and "return" for selection. Programming of both methods is absolute identical.

5.4.3.2 Glucose

After choosing this menu item you find a submenu with the menu items "unit", "sample warning", "controls", "value correction" and "return".

Submenus "unit" and "sample warning" are self-explanatory. Programming the controls was explained in chapter 4.

5.4.3.3 Lactate

After choosing this menu item you find a submenu with the menu items "unit", "sample warning", "controls" and "value correction" and "return".

Submenus "unit" and "sample warning" are self-explanatory. Programming the controls was explained in chapter 4.

5.4.3.4 Value correction

This function is used for adapting the values of SUPER GL ambulance to the values of a pilot unit, i.e. a clinical analyser. It is a fact that there are different methods for determining glucose concentration in blood. Thereby also exist small differences of the results accrue. By adapting the devices the doctor gets the possibility to place a correct diagnostic or track the therapy.

You could correct the slope m and the ordinate intercept n of a line. For tracking the influence of this changing you find in the end of the display typical glucose values which change by correcting "m" and "n". The changing of the digit you do by turning, the selection of "m" or "n" you do by pressing short the jog dial. If you want to leave this function press the jog dial for a long time.

5.4.4 Select method

This function allows the selection of methods which will be determined for the samples. There are three possibilities: "glucose", "lactate" and "glucose/lactate".

5.4.5 Plasma reference glucose

Using this function you are able to change the display of glucose values. This menu item depends on the equipment version of SUPER GL ambulance.

Using „Plasmaref. Glucose non active" the glucose values, which came from blood samples will be displayed as blood sample values.

Using „Plasmaref Glucose activated" the instrument will determine the glucose and additional the haematocrit value for each sample. Both values will be used to calculate the blood value into a plasma value. So plasma values will be displayed although the sample is from whole blood.

If this function is activated blood samples (red coloured) and red coloured control values will be signed with "Glu-P". Additional at measuring samples series printer writes out the sign "Glucose-Hemolysate-Samples Plasmaref." in each head of samples series print.

5.4.6 Language

There are four languages available. You select the language by pressing the jog dial. It will be selected the language between the " * ".



There are displays, which could not show Cyrillic characters. In this case it is difficult to leave the menu item.

5.4.7 EDP connection

In this function you could adjust different data sets and parameters for data communication. These settings should be done by specialists.

5.4.8 Select printer

You could choose between two types of printer. Standard printer is DPU 414.

6 Maintenance and troubleshooting

6.1 Introduction

This chapter gives information on maintenance of the SUPER GL ambulance and about problems that may occur and how you might be able to solve them yourself.

If you are unsure about certain aspects, DO NOT try anything you might think appropriate without qualified technical help. DO NOT open the device without an authorized service technician*! Please contact our service hotline free of charge!

6.2 Maintenance

The SUPER GL ambulance needs maintenance once a year by trained personnel. The display will show the message "SERV" after expiration of the maintenance rate (only in STAND BY).

Please contact the manufacturer or distributor immediately to make an appointment for service.

If you want to do the maintenance by yourself please note advice: When the maintenance will be done by manufacturer or distributor you will get a necessary update of the software of the device. So please catch up on necessity of an update!

6.3 Servicing

The following operations can and should be carried out by the operator.

These actions are part of diligent care and serve to enhance the device's life span. They are NOT maintenance or service work, these may only be carried out by authorized service personnel*!

6.3.1 Cleaning and disinfection

Please adhere to the regulations valid in your laboratory with regard to cleaning and disinfecting the device. For disinfection wipe the entire accessible surface of the device with a cloth containing disinfectant. Use a disinfectant for surface disinfection! Also note the instructions of the manufacturer of the disinfectant.

6.3.2 Exchange of pump head

For changing the pump head proceed as follows in the order specified:

1. Switch off the device
2. Open the device cover
3. Remove the hoses 2 and 3

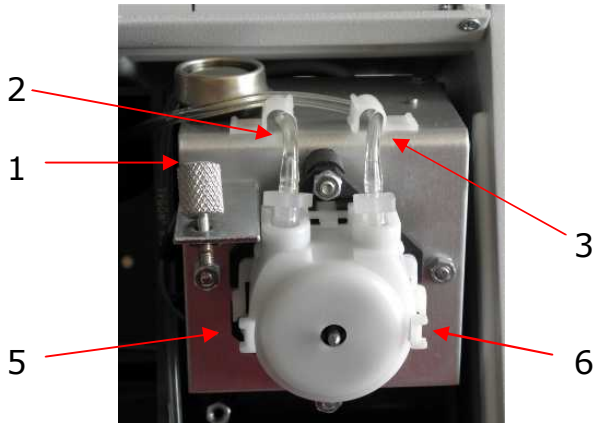

Fig. 6.1 View of pump and hoses

4. Loosen the knurled head screw 1
5. Tilt the pump upwards
6. Remove pump head gently pressing the springs at the sides (5,6)

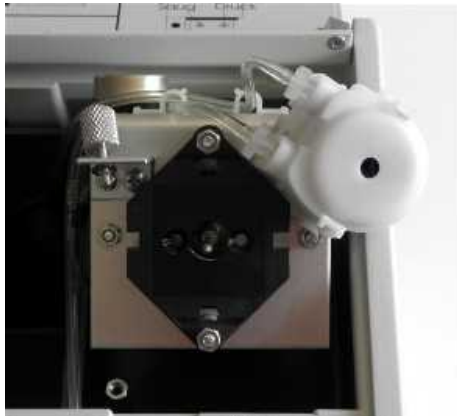

Fig. 6.2 Removed pump head

7. To install the new pump head follow the instruction in reverse order

6.3.3 Exchange of canula and washing container



Observe step 3 when removing the washing container! Otherwise leaking system solution damage the device!

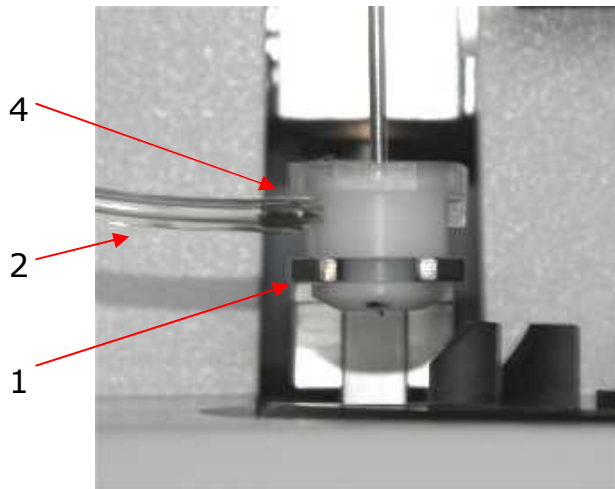

Fig. 6.3 View washing container

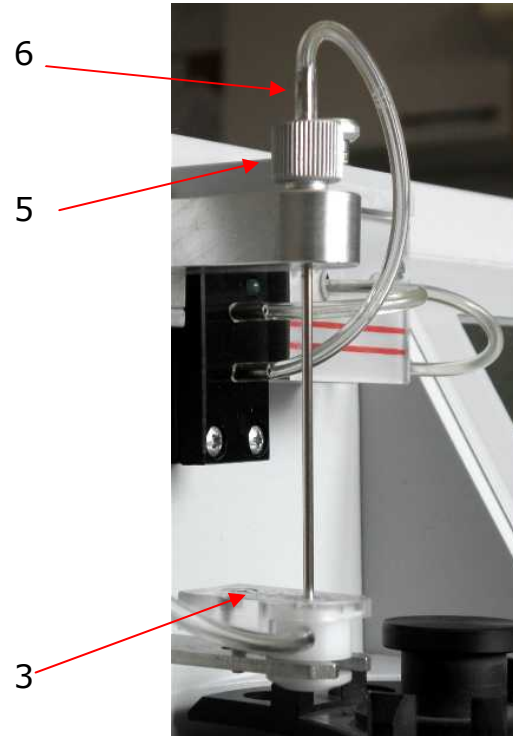

Fig. 6.4 View sample canula

Removal

1. Turn off the device
2. Remove the hose 6
3. Remove hose 2 from the canula of the washing container and put them on the hose holder
4. Loosen the knurled head screw 5
5. Remove canula
6. Loosen screw in position 3
7. Remove washing container from the holding-down 1

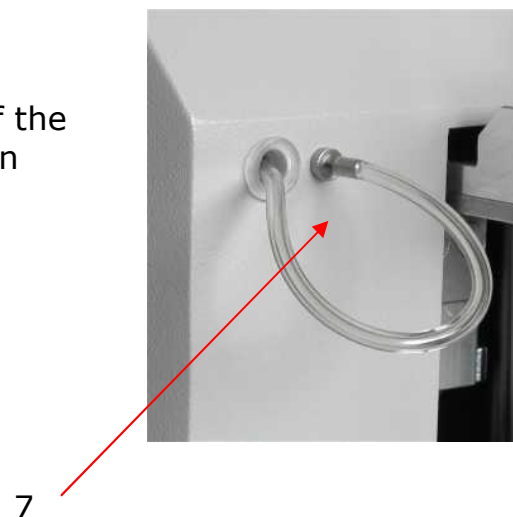

Fig. 6.5 View hose holder

Installation (s.fig. 6.3 and 6.4)

1. Insert the washing container into the holding-down 1
2. Fix screw in position 3
3. Connect the hose 2 from the hose holder 7 to the canula 4 of the washing container
4. Insert sample canula into position 5 and into washing container
5. Put on the knurled head screw 5 and fix it.
6. Connect the hose 6 to the sample canula.

6.3.4 Exchange of sensor

Removal of sensor

1. Open the sensor holder by pulling the button

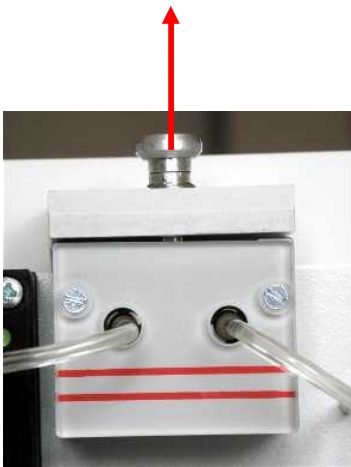

Fig. 6.6 Sensor holder closed

2. Remove the sensor



Fig. 6.7 Sensor holder open

Installation of Sensor

1. Open the packaging and take out the sensor
2. Open the sensor holder by pulling the button
3. Insert sensor
4. Close the sensor holder

6.3.5 Exchange of supply and waste container

To avoid interference with the operation of the device, it is recommended to exchange the containers only in „STAND BY“ mode and when the washing container and the sample canula are installed. Furthermore, the supply container that was last emptied should be used as a waste container because the repeated use of containers could affect the function of the level sensor.

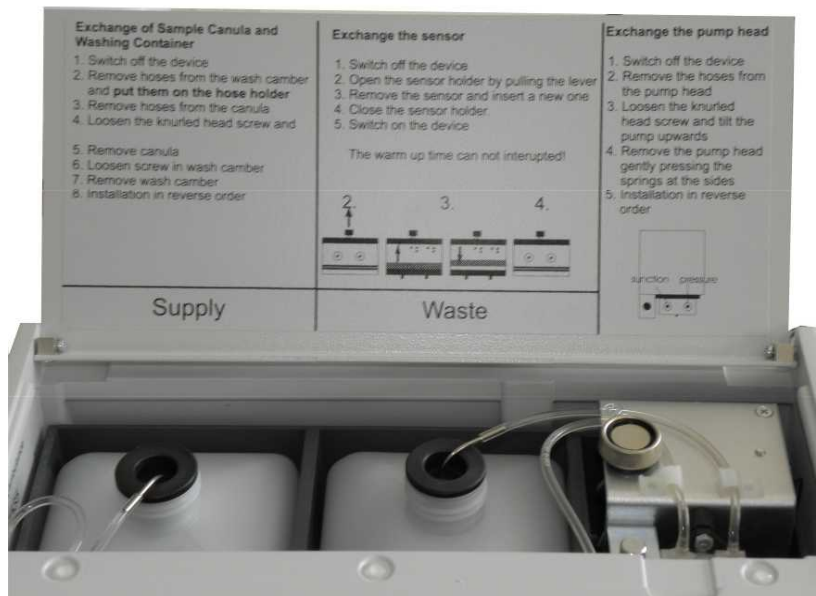

Fig. 6.8 View of supply and waste container

Removal of Supply- and Waste Container

1. Open the device cover
2. Remove the canulas
3. Remove the containers (supply left, waste right)

Insertion of Supply- and Waste Container

1. If necessary, open the device cover
2. Insert the containers (supply left, waste right)
3. Open the containers and insert the canula
4. Close the device cover

6.3.6 Exchange batteries

If the display shows "Warning Battery Empty" after having turned the device on or during maintenance, the batteries have to be changed. The battery compartment is on the back side of the device (see chapter 4.3). To change the batteries, proceed as follows:



Attention! Always exchange the complete set of batteries! Only use batteries of the same type! Batteries changing should be done during max. 5 minutes!

1. Turn off the device
2. Open cover of the battery compartment with a slight pressure on the clip
3. Remove used batteries
4. Insert new batteries as shown in the illustration inside the battery compartment
5. Close cover of battery compartment

6.3.7 Switching of the device

To switch off the device for a longer period of time or for transport, proceed as follows:

1. Rinse the device
2. Empty the system by removing the hose from the supply bottle and push the menu item "Emptying" by pressing the jog dial
3. Switch off the device and disconnect. Please store all consumables as written at the packages

Disposing of the device:

For the disposal of devices please ask your distributor.

6.4 Error messages / Troubleshooting

6.4.1 Warnings

Before printing the measured results, the device checks whether set warning limits have been exceeded. The sample warning limits (chapter 5) are relevant for the determination of patient's samples. In contrast for control samples the control limits (chapter 4) are the determining factor.

The following warning are displayed and printed:

Warning	Explanation
++++	Values above measuring range limit
-----	Values below measuring range limit
!!	Below or above the sample warning or control limits
*!	Previous control measurement outside the control limits
Warning Battery Empty	Batteries are dead. Exchange batteries!

Fig. 6.9 Table of warnings

6.4.2 Mechanical Errors

If the device displays following errors the user can't even do anything without the help of trained service staff. The displays are only a better description for service.

Error code	Error location	Error description	Action
1, 2, 3	1-8	<ul style="list-style-type: none"> • internal error 	<ul style="list-style-type: none"> • Call service!
4	1	<ul style="list-style-type: none"> • internal error 	<ul style="list-style-type: none"> • Call service!
4	4/5	<ul style="list-style-type: none"> • Lifter / rotor can't move out of it's reference position 	<ul style="list-style-type: none"> • check whether lifter/rotor is blocked • restart device • If lifter/rotor is not blocked and error code is displayed again: Call service!
5	1	<ul style="list-style-type: none"> • internal error 	<ul style="list-style-type: none"> • Call service!
5	4/5	<ul style="list-style-type: none"> • lifter/rotor can't find it's reference position 	<ul style="list-style-type: none"> • check whether lifter/rotor is blocked • restart device • If lifter/rotor is not blocked and error code is displayed again: Call service!
5	7	<ul style="list-style-type: none"> • internal error 	<ul style="list-style-type: none"> • Call service!
6	1	<ul style="list-style-type: none"> • internal error 	<ul style="list-style-type: none"> • Call service!
6	4/5	<ul style="list-style-type: none"> • lifter/rotor can't move out of it's reference position • lifter/rotor can't find it's reference position 	<ul style="list-style-type: none"> • check whether lifter/rotor is blocked • restart device • If lifter/rotor is not blocked and error code is displayed again: Call service!
6	7	<ul style="list-style-type: none"> • sensor does not have proper contact 	<ul style="list-style-type: none"> • reinsert sensor • restart device • If error code appears again: Call service!
7	4	<ul style="list-style-type: none"> • Lifter can't move into the sample taking or the prepricking position 	<ul style="list-style-type: none"> • check whether lifter is blocked • check sample cup (lid too strong or cup too short?)
7	7	<ul style="list-style-type: none"> • internal error 	<ul style="list-style-type: none"> • Call service!
7, 8	5	<ul style="list-style-type: none"> • rotor can't move into the sample taking or the prepricking position 	<ul style="list-style-type: none"> • check whether rotor is blocked • restart device • If rotor is not blocked and error code is displayed again: Call service!

Fig.. 6.10 Table error codes

6.4.3 Other errors

Error Message	Error Description	Action
operating period of sensor is expired exchange sensor	<ul style="list-style-type: none"> • maximum life time of the sensor is reached 	<ul style="list-style-type: none"> • install new sensor
storage time of sensor is expired exchange sensor	<ul style="list-style-type: none"> • sensor is expired 	<ul style="list-style-type: none"> • install new sensor
sensor used up exchange sensor turn off device	<ul style="list-style-type: none"> • maximum number of samples for sensor is reached 	<ul style="list-style-type: none"> • install new sensor
supply system solution key = canula o.k.	<ul style="list-style-type: none"> • supply container is empty 	<ul style="list-style-type: none"> • put a new bottle supply container in supply position • insert intake canula into supply container • put empty supply container into waste position • insert waste canula into waste container • confirm by pushing jog dial
waste container full empty! key = canula o.k.	<ul style="list-style-type: none"> • waste container is full 	<ul style="list-style-type: none"> • put empty supply container into waste position • insert waste canula into waste container • confirm by pushing jog dial
temperature too high	<ul style="list-style-type: none"> • room temperature too high • temperature sensor defective 	<ul style="list-style-type: none"> • call service if room temperature is not too high • device can be operated up without temperature compensation up to a point
temperature too low	<ul style="list-style-type: none"> • room temperature too low • temperature sensor defective 	<ul style="list-style-type: none"> • call service if room temperature is not too low • device can be operated up without temperature compensation up to a point

Fig. 6.11 Table error messages

6.4.4 Measuring Errors

Glucose and lactate are determined using the enzymatic-amperometric measuring principle. The measuring signal is produced as a current change at an electrode due to a chemical reaction with the immobilized enzyme.

In the SUPER GL ambulance measuring process is used that operates with a minimum amount of sample material. The hose between canula and sensor is critical for the proper functioning of this process. Therefore, this hose must only be replaced by an original spare part.

As with all flow systems, unobstructed flow through and imperviousness of the canal between the sample canula and the hose pump is very important for the proper functioning of the device.

Always keep in mind that the hose pump works as a suction pump and that it produces a low pressure in the system. Leaking liquid is always a sign of permeability, e.g. worn seals of the washing container, loose hoses or an incorrectly inserted sample canula.

Check for unobstructed flow and leakage:

Switch off the device and switch it back on after 2 seconds. Thereby making sure that the pump is working. Make sure that the pump is turning. Uncover the waste bottle and watch whether liquid drops in regular intervals (1-2 drops per second). In this case check that the solution flows through the hose to the pump free from air. If it does, there is no problem in the flow system.

If no liquid is dropping out, the system is either leaky or obstructed. In this case proceed as follows:

Remove the hose from the suction side of the hose pump and put a matching injection syringe onto the hose. With the syringe, suck liquid out of the supply bottle. Watch the liquid in the hose between sample canula and sensor. There are three possible reactions:

- The syringe can easily be moved, there are many air bubbles or only air in the hose. That means the system is leaking. The easiest way to find the leak is to look where the air bubbles occur. Check all connections and if necessary exchange the hoses and the washing container.
- The syringe can hardly be moved and the liquid in the hose barely moves. That means the system is obstructed. Loosen the hose from the washing container and attach it to the provided connector. Loosen the screw of the sample canula and pull the canula out of the washing container. Place the sample canula in a glass. Fill the syringe with distilled water or system solution and press the water from the hose toward the sample canula. The liquid should come out of the canula. If it does not, clean the canula with a cleaning wire and / or exchange the sensor.
- The syringe can be moved evenly but with resistance and the liquid flows back and forth inside the hose. In this case exchange the pump head of the peristaltic pump after checking the liquid run also with the hose at the pressure side of the pump.

With these simple measures most problems in the flow system can be solved. The problems can result in the following:

Scattering measuring values:

Could also be a result of incorrect sample preparation. Check by repeated measuring of some standard cups the precision. A defect sensor could also be the cause.

Calibration is not stable, often error variation/drift too high

Could be caused by extreme temperature variations (e.g. direct sun)

Calibration not possible, value too low

A defective (insensitive) sensor could also be the cause.

Frequent occurrence of the error "margin maximum"

Obstruction or leakage of hose system, system solution empty

7 Technical data

Measuring time per sample Single sample Series measuring	50 sec. 50 sec.
Measuring range Glucose Lactate	0,6 – 50 mmol/l (11 – 910 mg/dl) 0,5 – 30 mmol/l (4,5 – 270 mg/dl)
Amount of sample material	10 / 20 µl sample diluted with 500 / 1000 µl hemolysate-system-solution
Precision (24 samples) Glucose (216 mg/dl) Lactate (90 mg/dl)	< 1,5 % < 2,5 %
Storage period of sensor	12 month
Storage temperature of sensor	+ 2 °C up to + 8° C
Life time of sensor	3 month
Interfaces Printer EDP	parallel, Centronics V 24
Operation temperature	+ 15 °C up to + 35 °C
Storage temperature (without sensor)	- 10 °C up to + 50 °C
Supply voltage	12 V DC
Power consumption	Approx. 10 W
Classification according MPG	In-vitro-Diagnostic
Dimensions (W x H x D)	300 mm x 230 mm x 300 mm
Weight	Approx. 7 kg
Manufacturer	Dr. Müller Gerätebau GmbH Burgker Str. 133 01705 Freital

Fig. 7.1 List of technical data

Statistik I - Labor

1 Allgemeines

Das in den SUPER GL ambulance implementierte Qualitätskontrollsystem ist berücksichtigt die Forderungen der deutschen Bundesärztekammer gemäß RiliBäk 2008, die ausschließlich für Deutschland gelten. Deshalb ist dieser Programmteil nur in der deutschen Sprache verfügbar.



Die nachfolgenden Ausführungen dienen lediglich der Bedienung des Programmes. Das Programm entbindet nicht davon, die RiliBÄK als Ganzes zu kennen und deren Regeln zu befolgen.

In diesem Zusammenhang weisen wir darauf hin, dass wir als Hersteller empfehlen, täglich zwei Kontrollen mit unterschiedlichen Zielwerten zu messen.

2 Beschreibung der Menüpunkte

Um zu dem Menüpunkt „Statistik“ zu gelangen, beginnt man im „STAND BY“, wählt dann den Punkt „Dienstprogramme“, dann den Punkt „Statistik“ und dann den Punkt „Stat. Labor“ an. Damit gelangt man in ein Menü mit den Punkten „Glukose“, „Laktat“ und „Progr. Statistik“. Da die Untermenüs der Punkte „Glukose“ und „Laktat“ identisch sind, beschränken sich die nachfolgenden Ausführungen diesbezüglich auf den Punkt „Glukose“.

Der Punkt „Progr. Statistik“ ist eingewiesenem Personal vorbehalten und durch ein zusätzliches Passwort geschützt. Deshalb wird er als Letztes beschrieben, obwohl in ihm die Aktivierung der Statistik für die jeweilige Methode erfolgt.

I. Glukose

Bei Anwahl dieses Punktes erscheinen die im Folgenden beschriebenen Untermenüs:

Kontrolle 1
Kontrolle 2
Kontrolle 3
zurück

Diese drei Punkte haben identische Untermenüs. Deshalb beschränkt sich die Beschreibung auf die Kontrolle 1.

Nach Auswahl des Punktes Kontrolle 1 erscheinen die Untermenüs:

Bewerten
Drucken
Zurück

II. Bewerten

Bei Anwahl dieses Punktes werden alle bisher gemessenen Ergebnisse der Kontrolle 1 als Liste angezeigt. Durch Drehen des Jog Dials kann man sich in der Liste nach oben oder unten bewegen. Durch Drücken des Jog Dials wird der Messwert, der sich zwischen den Sternchen befindet, aus der Bewertung herausgenommen. Er wird durch ein „-“ als ungültig gekennzeichnet. Beim Ausdrucken erscheinen solche Werte als Ausreißer, für die eine Begründung angegeben werden muss. Ein weiterer Druck auf den Jog Dial macht den Wert wieder gültig.

Am Ende der Liste befindet sich der Punkt „zurück“, mit dessen Hilfe man das Menü wieder verlassen kann.

III. Drucken

Bei Anwahl dieses Punktes wird eine RiliBÄK 2008 - gerechte grafische Darstellung der Ergebnisse der Einzelmessungen und die Ergebnisse der zugehörigen Berechnungen ausgedruckt. Es wird eine Bewertung vorgenommen, ob das System in Ordnung ist oder nicht. Voraussetzung dafür ist allerdings, dass im Menüpunkt „Prog. Methode“, Unterpunkt „Glukose“, Unterpunkt „Kontrollen“ die korrekten unteren Warngrenzen und oberen Warngrenzen eingestellt wurden. Dabei sind die Angaben auf den Beipackzetteln nicht verbindlich, sondern die in der RiliBÄK 2008 angegebenen Grenzen, für Glukose z.Z. +/- 11%. Wechseln Sie ggf. das Kontrollmaterial.

IV. Prog. Statistik

Nach Eingabe des Kennwortes erscheinen in der Anzeige folgende Untermenüs:

Aktivieren Stat
Zeitpunkt Kont.
Reset Kontr. 1
Reset Kontr. 2
Reset Kontr. 3
Reset Statistik
Zurück

V. Aktivieren Stat

Die Anwahl dieses Punktes führt zu einem Untermenü mit folgenden Punkten:

Glukose ein
Glukose aus
Laktat ein
Laktat aus
Zurück

Der anzuwählende Punkt wird durch Drehen am Jog Dial zwischen den Sternchen positioniert und durch Drücken des Jog Dials ausgeführt.

VI. Zeitpunkt Kont.

Die Anwahl dieses Punktes führt zu einem Untermenü mit folgenden Punkten:

erste Ko tägl.
letzte Ko tägl.
zurück

Der anzuwählende Punkt wird durch Drehen am Jog Dial zwischen den Sternchen positioniert und durch Drücken des Jog Dials ausgeführt. Je nach Wahl wird die erste täglich gemessene Kontrolle oder die letzte täglich gemessene Kontrolle für die Bewertung abgespeichert. Dies gilt bei jedem Bedienerwechsel neu.

Reset Kontr. 1, Reset Kontr. 2, Reset Kontr. 3, Reset Statistik

Diese Punkte sind selbsterklärend, wobei Reset = Löschen bedeutet.

ONLY VALID IN GERMANY

Statistik II - Praxis

I. Allgemeines

Diese Form der Statistik darf in Deutschland nur angewandt werden für POCT- Messungen, bzw. der Nutzung von unit use Reagenzien. Erkundigen Sie sich bei der für Sie zuständigen Organisation zu dieser Frage.

Für POCT- Messungen gibt diese Art der Statistik eine zuverlässige Qualitätskontrolle, die über das geforderte Maß hinausgeht. Die Benutzung entbindet jedoch nicht von der Pflicht der RiliBÄK-konformen Formulare für diese Qualitätskontrolle.

II. Beschreibung der Menüpunkte

Um zu dem Menüpunkt Statistik II (Statistik Praxis) zu gelangen beginnt man im „STAND BY“, wählt dann den Punkt „Dienstprogramme“ dann den Punkt „Statistik“ und dann den Punkt „Stat. Praxis“ an. Damit gelangt man in ein Menü mit den Punkten „aktivieren“, „Reset Statistik“ und „zurück“. Wählt man den Punkt „aktivieren“, erscheint ein weiteres Untermenü mit den Punkten „Glukose ein“, „Laktat ein“, „Glukose aus“, „Laktat aus“. Durch Wählen des entsprechenden Punktes löst man die jeweilige Aktivität aus.

„Reset Statistik“ dient dem Löschen der bisher gemessenen Kontrollenwerte. Dieser Bereich ist eingewiesenem Personal vorbehalten und deshalb passwortgeschützt.

Bei aktivierter Kontrolle werden bei Benutzung der Kontrollposition 3 (Anwählen im Punkt „Messen“, Unterpunkt „Kontrolle“) folgende Aktivitäten ausgelöst:

1. Es wird eine Bedienernummer abgefragt.
2. Die Kontrolle wird gemessen.
3. Es erscheint für jede aktivierte Methode ein spezieller Ausdruck mit folgendem Inhalt:
 - Name der Praxis (vom Anwender auszufüllen)
 - Zeitpunkt der Messung
 - Name des Untersuchers (vom Anwender auszufüllen)
 - Name der Kontrollprobe (vom Anwender auszufüllen)
 - Charge der Kontrollprobe (vom Anwender auszufüllen)
 - die letzten vier Kontrollprobenmessergebnisse
 - Bewertung der Messungen mit $R_{rel}/2$ als Maß für die voraussichtlich zu erreichende Präzision
 $R_{rel} = (\text{Maximum-Minimum})/\text{Mittelwert} \cdot 100\%$
 - relative Abweichung vom Zielwert

Bei jeder weiteren Messung wird der jeweils älteste Wert verworfen und der aktuelle hinzugefügt.